

SVD

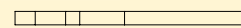

CASE 721 II SVD

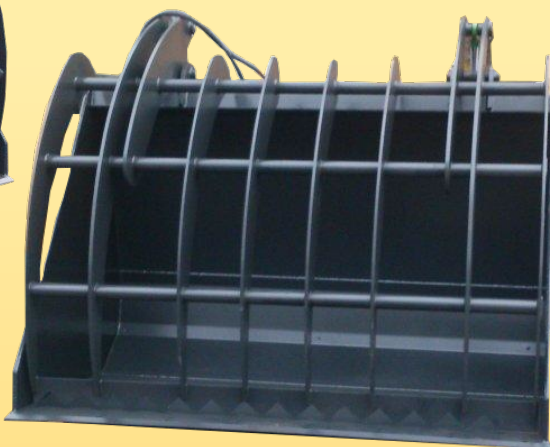
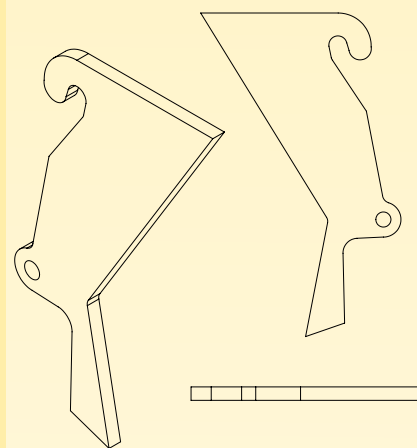
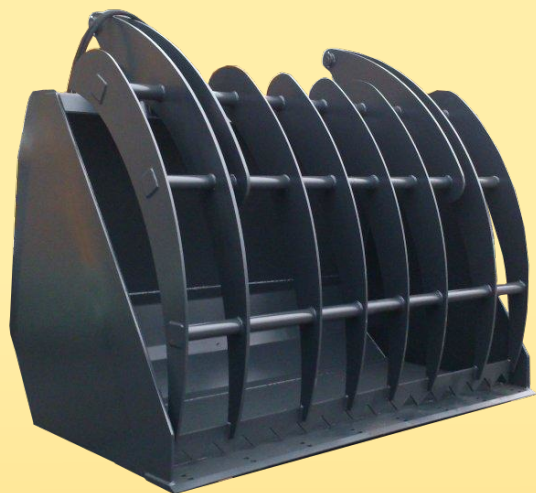
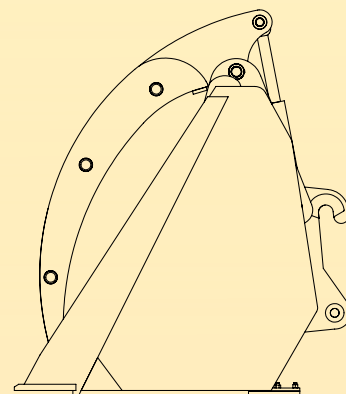
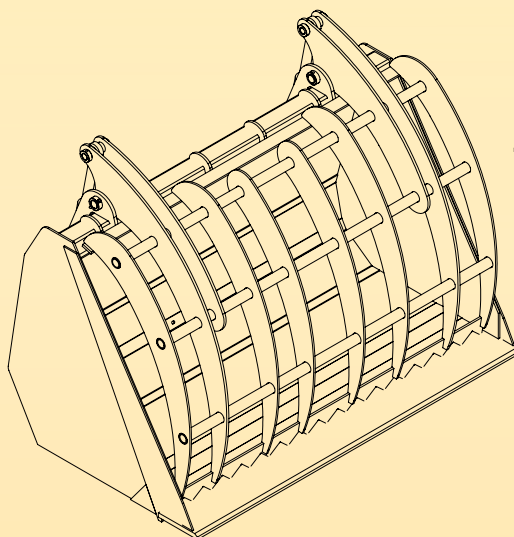
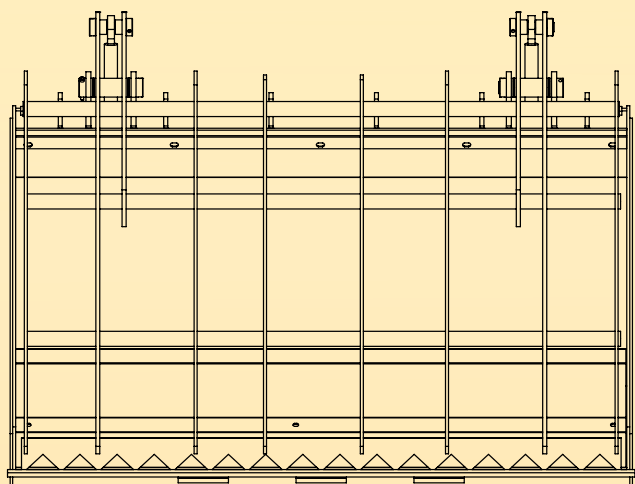

Model	Pojemność z normą SAE	Pojemność nasypowa	Waga	Szerokość	Głębokość	Wysokość	Cena
SVD-2030	2,11m ³	2,96m ³	1487kg*				
SVD-2130	2,22m ³	3,11m ³	1535kg*				
SVD-2230	2,33m ³	3,26m ³	1588kg*				
SVD-2330	2,44m ³	3,41m ³	1631kg*				
SVD-2430	2,55m ³	3,57m ³	1672kg*				
SVD-2530	2,66m ³	3,72m ³	1720kg*				
SVD-2630	2,77m ³	3,87m ³	1783kg*				